

Massivsauna

Komfort

Small

208 x 158 x 204 cm

MONTAGEANLEITUNG

Deutsch

DE

EN

FR



Inhaltsverzeichnis

1. Montage Vorbereitung	3
1.1. Benötigtes Werkzeug	4
1.2. Wartung und Reinigung	5
1.3. Entsorgung	5
1.4. Stückliste KOMFORT SMALL	6
2. Montage der Kabine	8
2.1. Montage des Bodenrahmens	8
2.2. Montage der Wandelemente	9
2.3. Montage Dach	14
2.4. Montage Lüftungsschieber	16
2.5. Montage Inneneinrichtung	16
2.6. Montage Zubehör	19
2.7. Montage Glastür	21
2.8. Montage Dachkranz	24
2.9. Montage Dachabdeckleiste	25
3. Grundriss	26
3.1. Grundriss „links“	26
3.2. Grundriss „rechts“	27

1. Montage Vorbereitung

Lesen Sie diese Montageanleitung gut durch und bewahren Sie sie in der Nähe der Sauna auf. So können Sie jederzeit Produktinformationen nachlesen.



Sie finden diese Montageanleitung auch im Downloadbereich unserer Webseite auf www.sentiotec.com/downloads.

Wichtige Hinweise:

- Kontrollieren Sie, bevor Sie mit der Arbeit beginnen, anhand der Stückliste, ob alle Einzelteile auch tatsächlich mitgeliefert wurden. Sollten Einzelteile ausnahmsweise fehlen, benachrichtigen Sie spätestens 14 Tage nach Erhalt der Kabine Ihren Händler.
- Der Raum, in dem die Saunakabine montiert wird, muss trocken sein und eine entsprechende Luftzirkulation gewährleisten.
- Der Fußboden muss waagrecht und eben sein, bevorzugt Stein- oder Fliesenboden.
- Für die Montagearbeiten der Kabine wird eine Mindestraumhöhe von 230 cm benötigt.
- Es muss ein Wandabstand von mindestens 5 cm eingehalten werden.
- Die Innen zu verwendenden Holzteile dürfen nicht mit Imprägniermittel behandelt werden.
- Für die Montage benötigen Sie einen Helfer.
- Holz ist ein Naturprodukt, das trotz guter Lagerung aufquellen, schwinden oder sich verziehen kann. Aus diesem Grund kann es vorkommen, dass bei der Montage etwas Kraft aufgebracht werden muss.
- Alle Verschraubungen müssen vorgebohrt werden.

Achtung!

Der Elektroanschluss darf nur durch eine Elektrofachkraft oder eine vergleichsweise qualifizierte Person ausgeführt werden.

1.1. Benötigtes Werkzeug

- Hammer und Beilageholz oder einen Gummihammer
- Akkuschauber mit Bits für Kreuzschrauben und Torx
- Rollmaßband
- Bohrer mit Durchmesser 3 mm, 10 mm, 20 - 30 mm (für Stromkabel Saunaofen)
- Wasserwaage
- Innensechskant-Schlüssel 1,5 mm
- Universalmesser
- Leiter
- Feinsäge



Dieses Symbol kennzeichnet Tipps und nützliche Hinweise

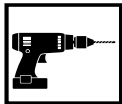

Vorbohren



Ablängen auf Naturmaß mit Feinsäge



Überprüfung des rechten Winkel:

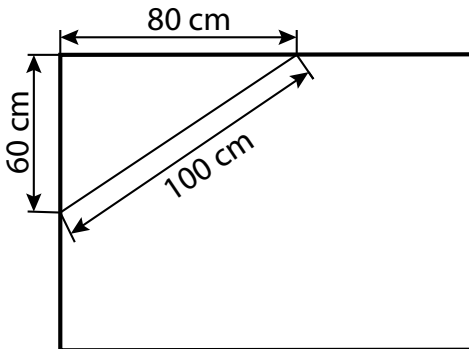

1.2. Wartung und Reinigung

- Die Sauna sollte mit einem feuchten Tuch gereinigt werden. Verwenden Sie nur warmes Wasser - keine Reinigungsmittel.
- Wird die Sauna längere Zeit nicht benutzt, empfehlen wir, die Kabine einmal im Monat aufzuheizen.



Harzgallen sind kein Reklamationsgrund. Da in Fichtenholz immer wieder Harzgallen vorkommen und man beim Aussortieren nicht erkennen kann in welcher Tiefe diese sich befinden.

Wenn diese knapp unter der Oberfläche sind brechen sie bei Hitzeentwicklung auf und „bluten“ aus.

Das ausgelaufene Harz kann man mit einem Aceton gedrängtem Lappen entfernen. Wenn lediglich Harztropfen entstehen, lassen Sie diese aushärten und schaben sie anschließend mit einem Messer vorsichtig ab.

DE

1.3. Entsorgung



- Entsorgen Sie die Verpackungsmaterialien nach den gültigen Entsorgungsrichtlinien.
- Altgeräte enthalten wiederverwendbare Materialien, aber auch schädliche Stoffe. Geben Sie Ihr Altgerät deshalb auf keinen Fall in den Restmüll, sondern entsorgen Sie das Gerät nach den örtlich geltenden Vorschriften.

1.4. Stückliste KOMFORT SMALL

Az	Bezeichnung	Maß
Bodenrahmen		
2	Bodenrahmen	66 x 9 x 4 cm
1	Bodenrahmen	204 x 9 x 4 cm
2	Bodenrahmen	156 x 9 x 4 cm
Wandelemente		
6	Wandelemente A/A	193 x 48 x 4 cm
3	Wandelemente A/B	193 x 48 x 4 cm
1	Lüftungselement A/B	193 x 48 x 4 cm
1	Elektroelement A/A	193 x 60 x 4 cm
1	Wandelement mit Glas	193 x 60 x 4 cm
1	Türstock schwellenlos mit Multiclips	202 x 72 x 4 cm
Dachelemente		
2	Dachelemente	146 x 49 x 4 cm
1	Dachelemente	146 x 48 x 4 cm
Ecksteher		
4	Ecksteher 90°	193 x 6 x 6 cm
Auflageleisten		
2	Dachauflageleisten	196 x 4 x 4 cm
2	Dachauflageleisten	145 x 4 x 4 cm
2	Dachabdeckleisten	192 x 1,2 x 4 cm
2	Dachabdeckleisten	152 x 1,2 x 4 cm
2	Bankauflageleisten	58 x 4 x 4 cm
2	Bankauflageleisten	100 x 4 x 4 cm
2	Montageleisten für Banksichtblende	26 x 4 x 4 cm

Az	Bezeichnung	Maß
Inneneinrichtung		
1	Bank	195 x 62 x 9 cm
1	Bank	195 x 53 x 9 cm
1	Rückenlehne	190 x 26 x 4 cm
1	Banksichtblende	195 x 35 x 4 cm
1	Ofenschutzgitter - Linde	57 x 75 x 2 cm
1	Ofenschutzgitter - Linde	45,5 x 55 x 2 cm
3	Montageleisten für Ofenschutzgitter - Fichte	7 x 2,5 x 2,5 cm
1	Kopfstütze	43 x 25 x 7 cm
1	Lampenschutzgitter	38 x 32 x 4 cm
1	Lüftungsschieber	52 x 14 x 1,5 cm
1	Bodenrost	70 x 53 x 4 cm
Glaselemente		
1	Glastür	191,5 x 59 x 0,8 cm
Dachkranzleisten		
1	Dachkranzleiste	208 x 6 x 4 cm
2	Dachkranzleisten	163 x 6 x 4 cm
Zubehör		
1	Türgriff Set Holz/Holz	
1	2 Türbänder 3308	
1	Türmagnet, Überschubblech	
1	Saunaleuchte	
1	3 Lfm. Silikonkabel 5 x 2,5mm ²	
1	3 Lfm. Silikonkabel 3 x 1,5mm ²	
32	Abdeckkappen	
1	Montagematerialset	
1	Montageanleitung	

2. Montage der Kabine

Die Kabine kann „rechts“ oder „links“ aufgebaut werden, beachten Sie dazu die Grundrisspläne auf Seite 26 und Seite 27.

2.1. Montage des Bodenrahmens

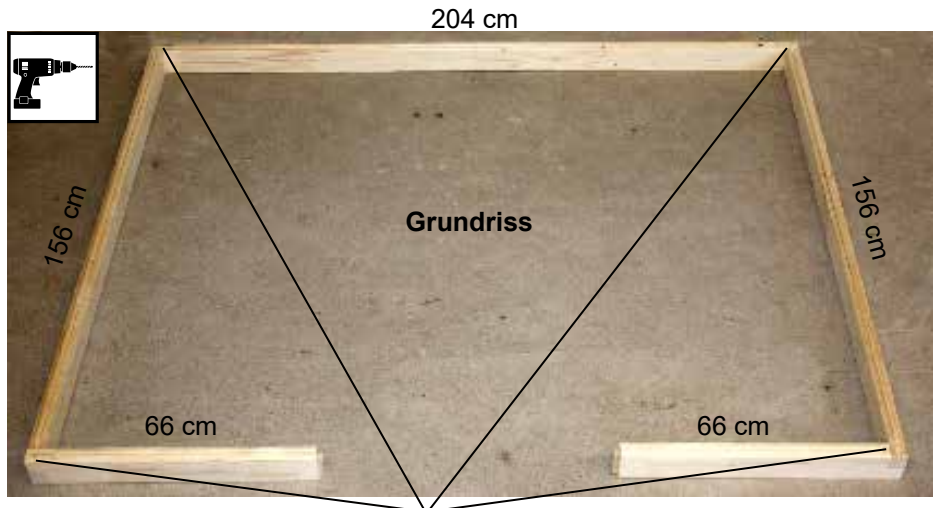

Bohrer 3mm, 4 Stk. Schrauben 4 x 70 mm



2.2. Montage der Wandelemente

Die Ecksteher und Wandelemente sind mit Nut und Feder verbunden und werden miteinander verschraubt. Der Türstock wird mittels „Multiclips“ mit den Wandelementen verbunden.



A bezeichnet immer die Sichtseite, dies ist auf der Oberseite der Wandelemente gekennzeichnet.

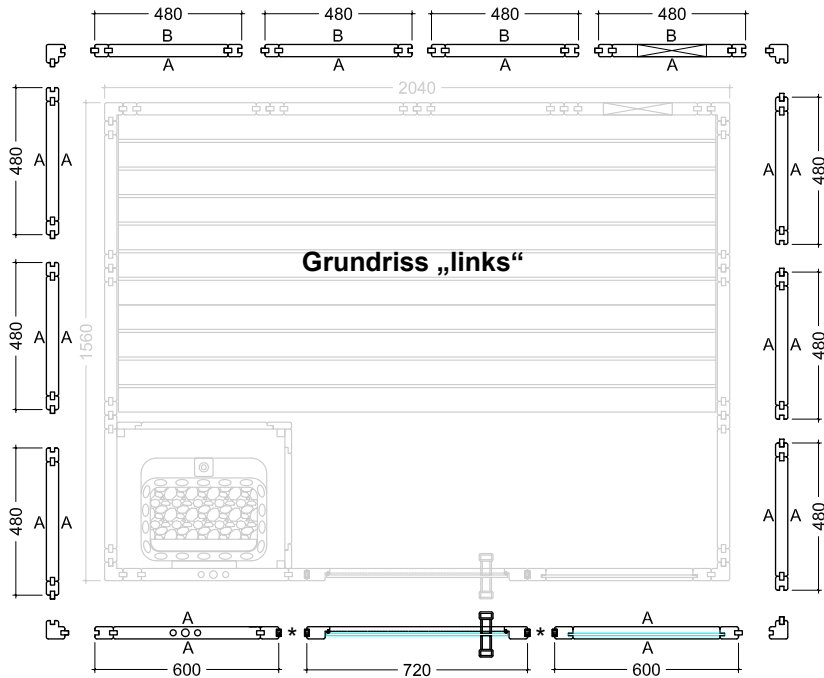

* Multiclips



8 Stk. Schrauben 6 x 120 mm
je Ecksteher



Symbolfoto



Symbolfoto

Montage Wandelemente



Das Elektroelement hat Bohrungen zum Verlegen der Kabel. Position siehe Grundrisspläne auf Seite 26 und Seite 27.



Elektroelement rechts -
Abluft links hinten.

Elektroelement links -
Abluft rechts hinten.



Symbolfoto



Symbolfoto

DE



Symbolfoto

4 Stk. Schrauben 6 x 100 mm

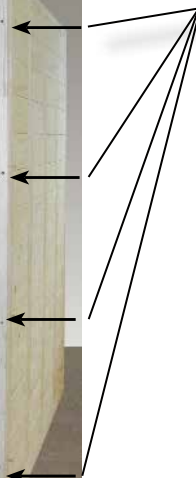

Türstock einsetzen

Transportleiste vom Türstock entfernen



Türstock einsetzen

Stecken Sie den Türstock von oben nach unten auf die Wandelemente. Achten Sie dabei auf die korrekte Ausrichtung der „Multiclips“ (siehe unten). Der Türstock muss bündig mit den Wandelementen sein.

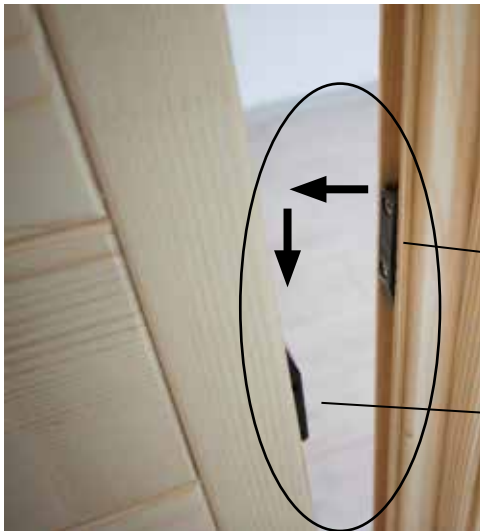

Multiclip



Verschrauben der Wandelemente



Überprüfen Sie die rechten Winkel, bevor Sie die Wandelemente verschrauben. Beachten Sie den Tipp auf Seite 4.



Bohrer 3 mm, 15 Stk. Schrauben 4 x 70 mm

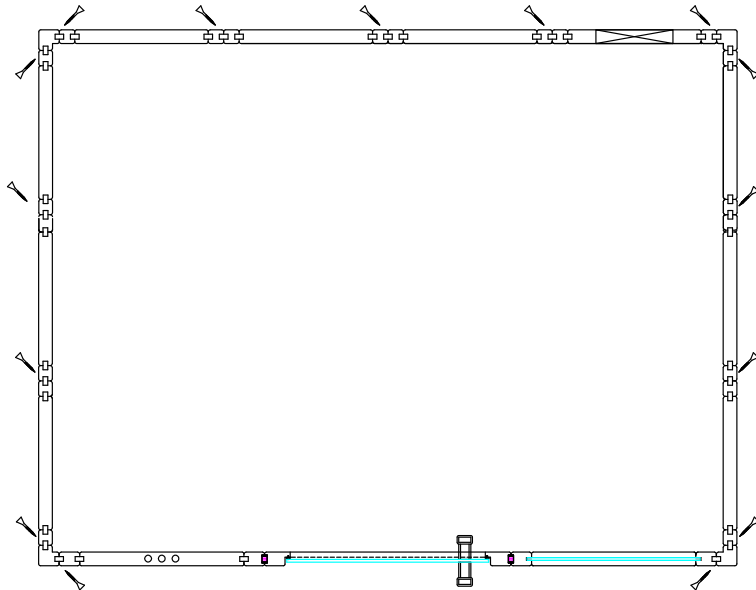

2.3. Montage Dach

Dachauflageleisten



Bohrer 3 mm, 14 Stk. Schrauben 4 x 70 mm

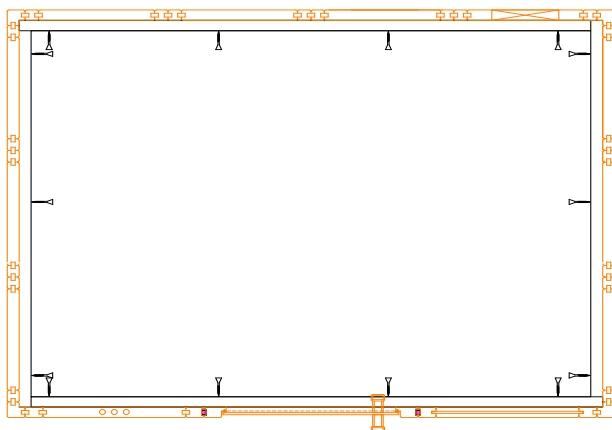

Dachelemente



DE

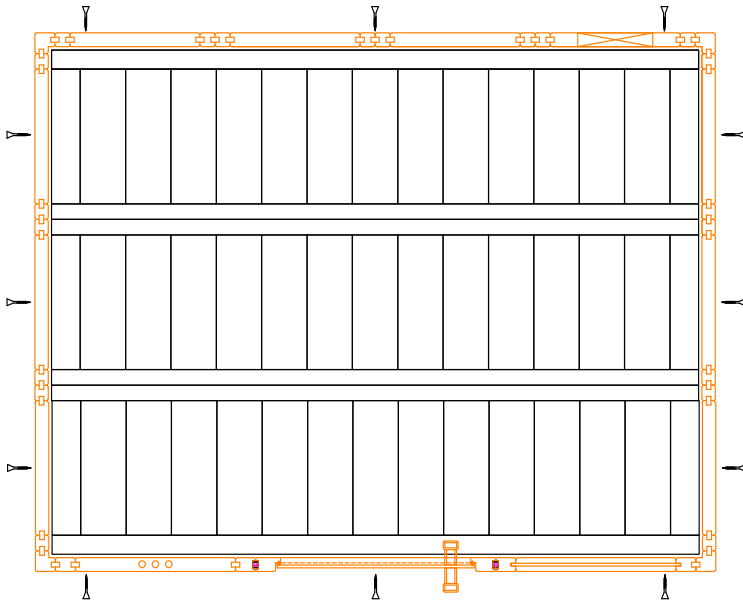

Bohrer 3 mm, 12 Stk. Schrauben 4 x 70 mm

2.4. Montage Lüftungsschieber



Bohrer 3 mm, 4 Stk. Schrauben 3,5 x 40 mm

2.5. Montage Inneneinrichtung

Bankauflageleisten

Bohrer 3 mm, 3 Stk. Schrauben 5 x 70 mm

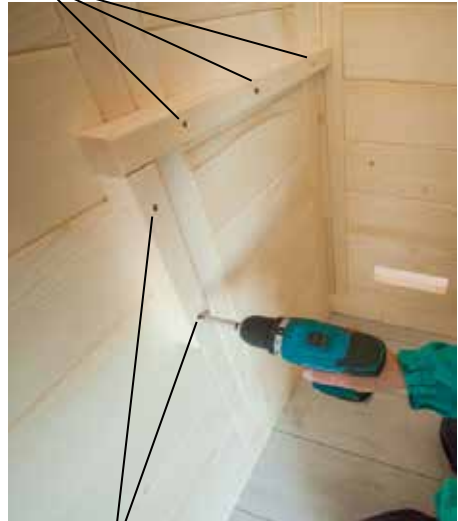

2 Stk. Schrauben 4 x 60 mm

Bohrer 3 mm, 3 Stk. Schrauben 5 x 70 mm



DE

2 Stk. Schrauben 4 x 60 mm

Banksichtblende



4 Stk. Schrauben 4 x 60 mm

Rückenlehne



Bohrer 3 mm, 3,5 Stk. Schrauben 3 x 40 mm

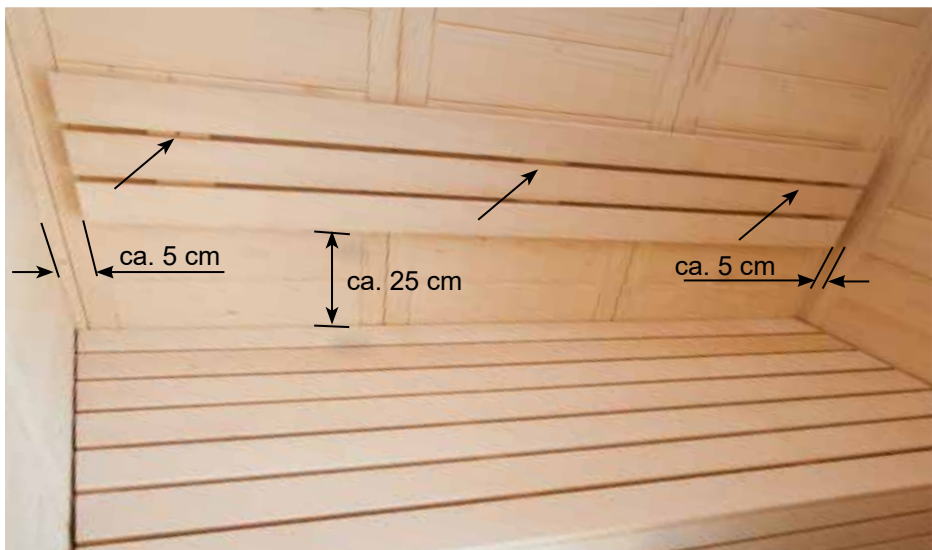

2.6. Montage Zubehör Saunaleuchte



Leuchtmittel einsetzen
(nicht im Lieferumfang enthalten)



Bohrer 3 mm, 2 Stk. Schrauben



4 Stk. Schrauben 3,5 x 40 mm



Ofenschutzgitter



Bohren Sie vor der Montage des Ofenschutzgitters den Auslass für das Ofenkabel im Elektroelement.



2 Stk. Schrauben 3,5 x 40 mm



4 Stk. Schrauben 3,5 x 40 mm



2.7. Montage Glastür

Die Glastür kann links und rechts angeschlagen werden.



Silikon- oder Papierbeilage für Glas-
türbeschläge auf beiden Seiten der
Glastüre

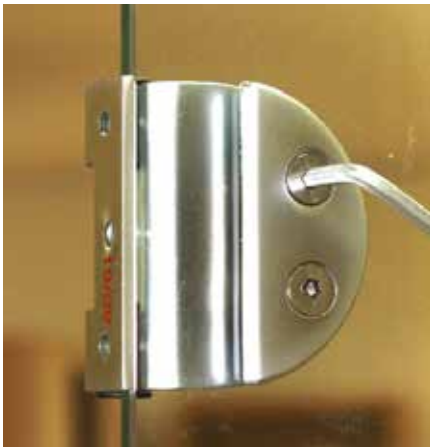

Schrauben 4 x 30 mm

Türgriff

Die Türgriffe werden von innen miteinander verschraubt.



Silikonring in Bohrungen einlegen



Symbolfoto

Türmagnet und Überschubblech



2.8. Montage Dachkranz



Montieren Sie den Dachkranz erst nachdem Sie die Kabel zum Saunaofen und zur Saunasteuerung eingezogen haben. Möglicherweise muss die Leiste beim Elektroelement ausgeschnitten werden.



Bohrer 3 mm, 10 Stk. Schrauben 3,5 x 40 mm

2.9. Montage Dachabdeckleiste



Montieren Sie die Dachabdeckleiste erst nachdem Sie die Kabel zum Saunaofen und zur Saunasteuerung eingezogen haben. Möglicherweise muss die Leiste beim Elektroelement ausgeschnitten werden.



DE

12 Stk. Schrauben 3,5 x 40 mm

3. Grundriss

3.1. Grundriss „links“

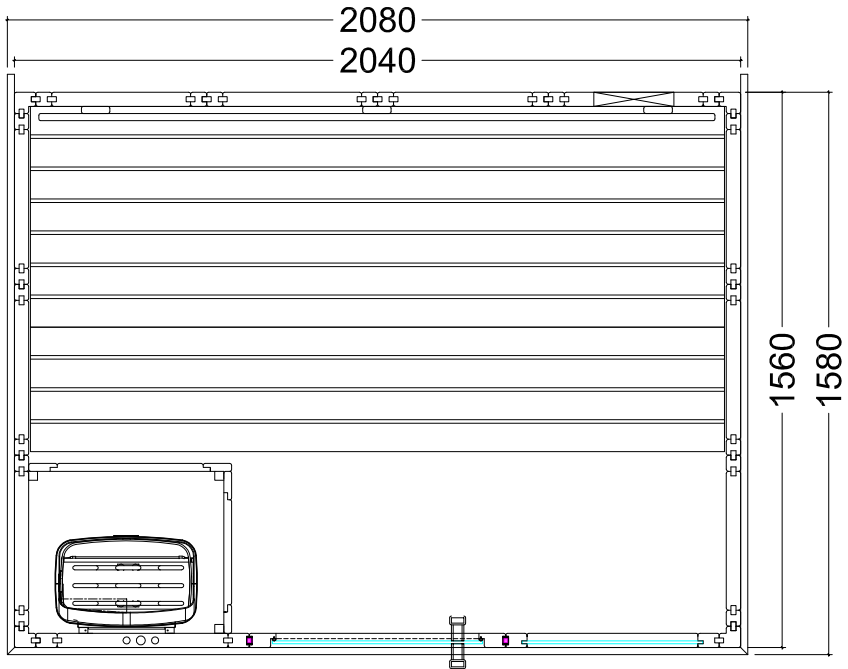

3.2. Grundriss „rechts“

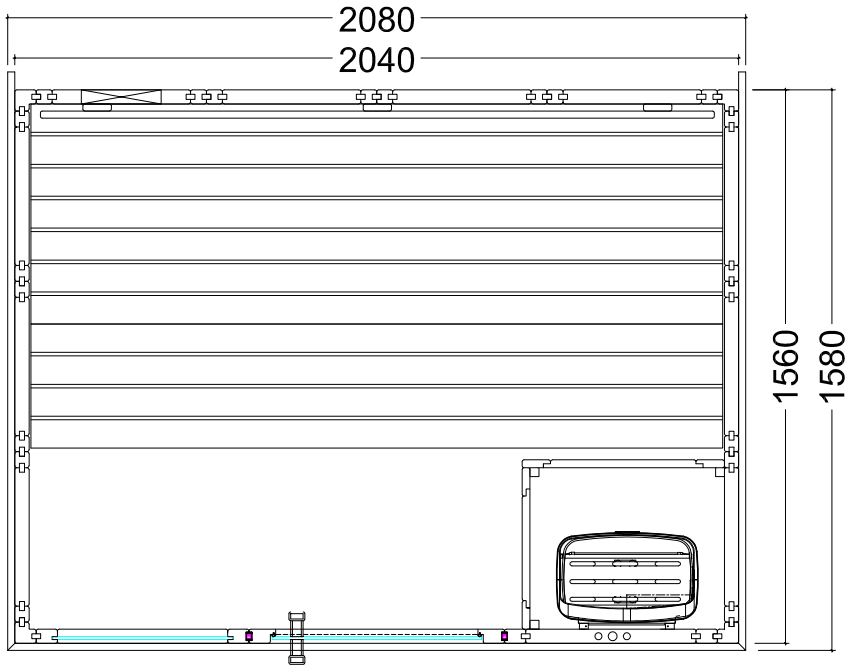



sentiotec GmbH | Division of Harvia Group | Wartenburger Straße 31, A-4840 Vöcklabruck
T +43 (0) 7672/22 900-50 | F -80 | info@sentiotec.com | www.sentiotec.com

Solid wood sauna

Komfort

Small

208 x 158 x 204 cm

INSTRUCTIONS FOR INSTALLATION AND USE
English

EN



Table of Contents

1. Preparing for installation	3
1.1. Tools required	4
1.2. Maintenance and cleaning	5
1.3. Disposal	5
1.4. KOMFORT SMALL parts list	6
2. Cabin installation	8
2.1. Base frame installation	8
2.2. Wall element assembly	9
2.3. Ceiling installation	14
2.4. Ventilation slit installation	16
2.5. Installing interior fittings	16
2.6. Installing accessories	19
2.7. Installing glass door	21
2.8. Installing roof trim	24
2.9. Installing ceiling cover slat	25
3. Floor plan	26
3.1. Left floor plan	26
3.2. Right floor plan	27

1. Preparing for installation

Read these assembly instructions carefully and keep them within reach when using the sauna so that you can look up product information at any time.



These assembly instructions can also be found in the downloads section of our website: www.sentiotec.com/downloads.

Important note:

- Before you begin work, check the parts list to ensure that all the individual parts have been delivered. If you discover any missing parts, notify your dealer within 14 days of receiving the sauna cabin.
- The room that the sauna is installed in must be dry and ensure an appropriate amount of air circulation.
- The floor must be level and even, preferably a stone or tiled floor.
- A minimum room height of 230 cm is required for the cabin installation work.
- A distance of at least 5 cm from the wall must be maintained.
- The inside of the wooden parts used must not be handled with any impregnating material.
- You need an assistant for the installation.
- Wood is a natural product that can swell, shrink or warp, despite good storage. For this reason, some force may be necessary during the installation.
- All screw fittings must be pre-drilled.

Attention!

The electrical connection may only be performed by a qualified electrician or similarly qualified person.

1.1. Tools required

- Hammer with a wooden head or a mallet
- Cordless screwdriver with bits for cross-head screws and Torx
- Roller tape measure
- Drill bits with a diameter of 3 mm, 10 mm, 20 - 30 mm (for sauna heater power cable)
- Spirit level
- 1.5 mm hexagonal socket wrench
- Utility knife
- Ladder
- Backsaw



This symbol indicates tips and useful information

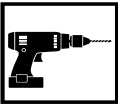

Pre-drill



Cut to real measurement with backsaw



Check the right angle:

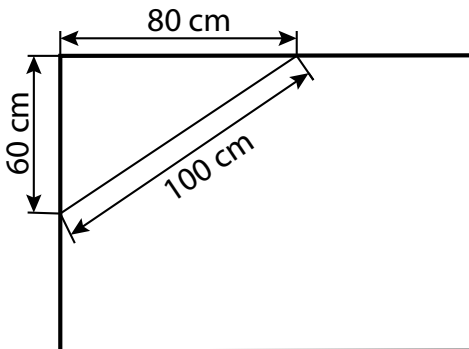

1.2. Maintenance and cleaning

- The sauna should be cleaned with a damp cloth. Only use warm water – no cleaning products.
- We recommend heating the cabin once a month if the sauna is not used for a long time.



Pitch pockets are not grounds for return, since they can always appear in spruce wood and the depth at which they lie cannot be detected during the sorting-out process.

If these are just under the surface, heat can cause them to soften and “bleed”.

The leaking pitch can be removed with a rag soaked in acetone. If only droplets of pitch occur, allow these to harden and then carefully scrape them off with a knife.

1.3. Disposal



- Please dispose of packaging materials in accordance with the applicable disposal regulations.
- Used units contain reusable materials as well as hazardous substances. Therefore, do not dispose of your used unit with household waste, but rather do so in accordance with the locally applicable regulations.

1.4. KOMFORT SMALL parts list

No. of items	Name	Dimensions
Base frame		
2	Base frame	66 x 9 x 4 cm
1	Base frame	204 x 9 x 4 cm
2	Base frame	156 x 9 x 4 cm
Wall elements		
6	A/A wall elements	193 x 48 x 4 cm
3	A/B wall elements	193 x 48 x 4 cm
1	A/B ventilation element	193 x 48 x 4 cm
1	A/A electrical element	193 x 60 x 4 cm
1	Wall element with glass	193 x 60 x 4 cm
1	Door frame, no step, with Multiclips	202 x 72 x 4 cm
Ceiling elements		
2	Ceiling elements	146 x 49 x 4 cm
1	Ceiling elements	146 x 48 x 4 cm
Corner posts		
4	Ecksteher 90°	193 x 6 x 6 cm
Support slats		
2	Roof support slats	196 x 4 x 4 cm
2	Roof support slats	145 x 4 x 4 cm
2	Roof cover slats	192 x 1,2 x 4 cm
2	Roof cover slats	152 x 1,2 x 4 cm
2	Bench support slats	58 x 4 x 4 cm
2	Bench support slats	100 x 4 x 4 cm
2	Mounting slats for bench screen	26 x 4 x 4 cm

No. of items	Name	Dimensions
Interior fittings		
1	Benches	195 x 62 x 9 cm
1	Bench	195 x 53 x 9 cm
1	Backrests	190 x 26 x 4 cm
1	Bench screen	195 x 35 x 4 cm
1	Heater protection grille - lime wood	57 x 75 x 2 cm
1	Heater protection grille - lime wood	45.5 x 55 x 2 cm
1	Headrests	43 x 25 x 7 cm
1	Lamp protection grille	38 x 32 x 4 cm
1	Ventilation slit	52 x 14 x 1.5 cm
1	Floor grid	70 x 53 x 4 cm
Glass elements		
1	Glass door	191.5 x 59 x 0.8 cm
Roof trim slats		
1	Roof trim slat	208 x 6 x 4 cm
2	Roof trim slats	163 x 6 x 4 cm
Accessories		
1	Door handle set wood/wood	
1	2 door hinges 3308	
1	Door magnet, sleeve plate	
1	Sauna lamp	
1	3 Silicon cables: 5 x 2.5 mm ²	
1	3 Silicon cables: 3 x 1.5 mm ²	
32	Cover caps	
1	Installation material set	
1	Installation instructions	

2. Cabin installation

The cabin can have a right or left set up, please note the corresponding floor plans on Page 26 and Page 27.

2.1. Base frame installation

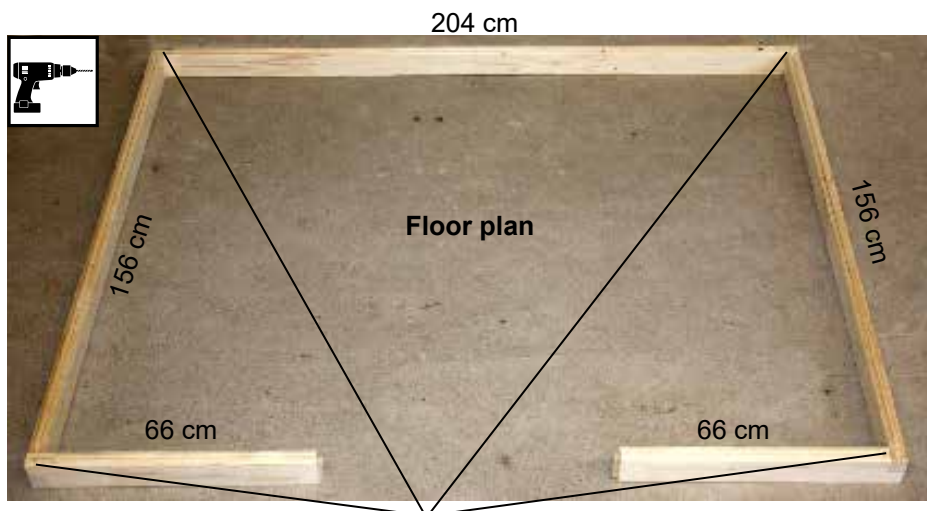

3 mm drill bit, 4 screws 4 x 70 mm



2.2. Wall element assembly

The corner posts and wall elements are connected with tongue and groove and are screwed together. The door frame is connected to the wall elements using “Multiclips”.



A always refers to the visible side. This is labelled on the top side of the wall elements.

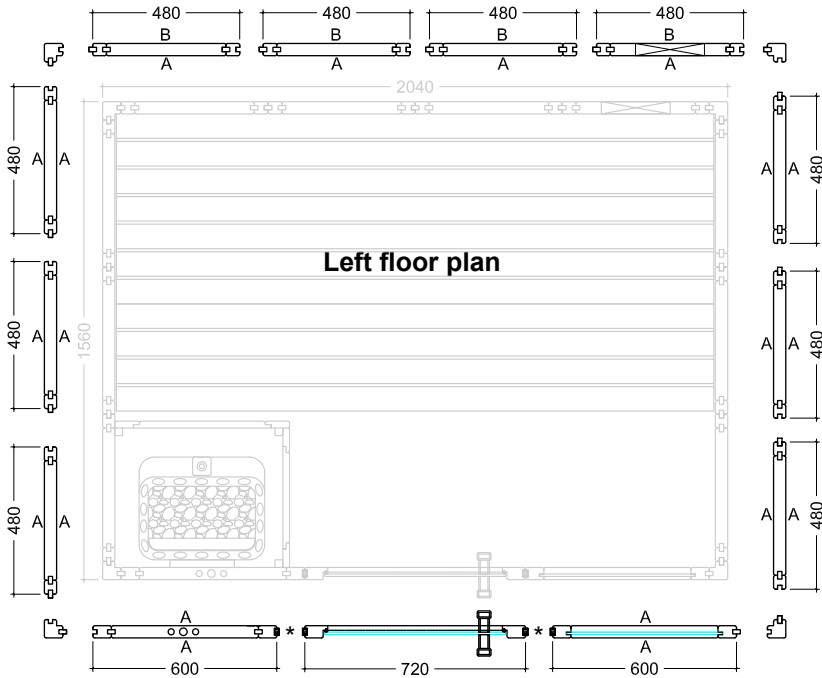

* Multiclips



8 screws 6 x 120 mm
per corner post



Symbolphoto



Symbolphoto

Installing wall elements



The electrical element has drill holes for laying cables. For the position see floor plans on Page 26 and Page 27.



Electrical element on left - Exhaust air on rear left.



Symbolphoto

Electrical element on right - Exhaust air on rear left.



Symbolphoto

EN



4 screws 6 x 100 mm

Symbolphoto

Inserting the door frame



Remove transport strip from the door frame



Insert door frame

Push the corner post from above down onto the wall elements. When doing this, ensure that the Multiclips are correctly aligned (see below). The door frame must be flush with the wall elements.

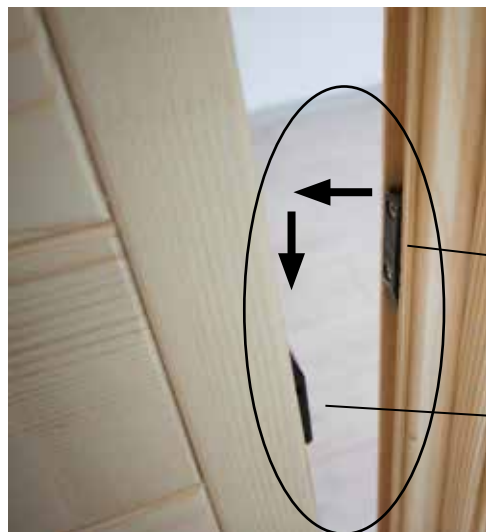

Multiclip



Screwing wall elements together



Check the right angle before screwing the wall elements together. Observe the tip on page 4.



EN

3 mm drill bit, 15 screws 4 x 70 mm

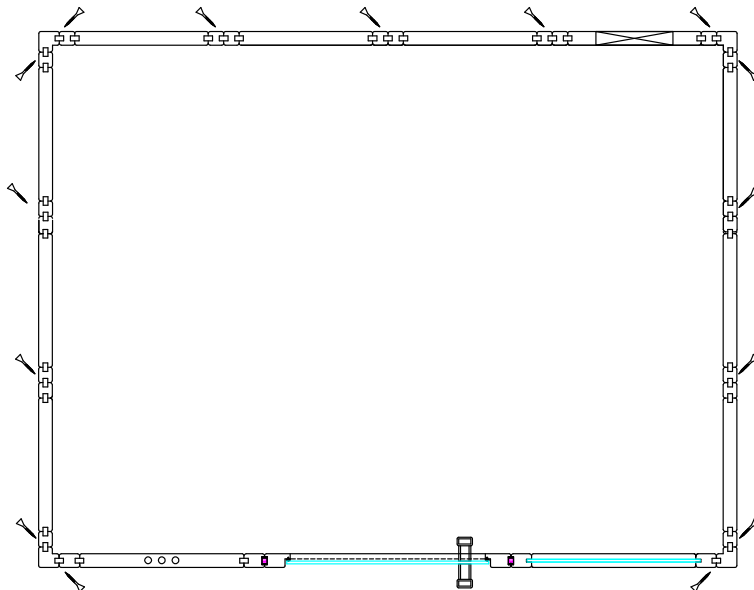

2.3. Ceiling installation

Roof support slats



3 mm drill bit, 14 screws 4 x 70 mm

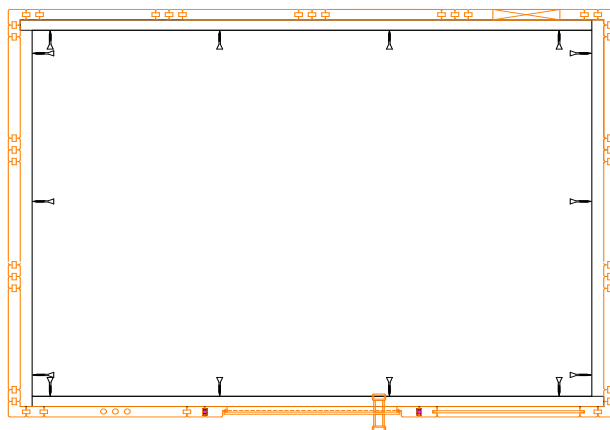

Ceiling elements



Symbolphoto

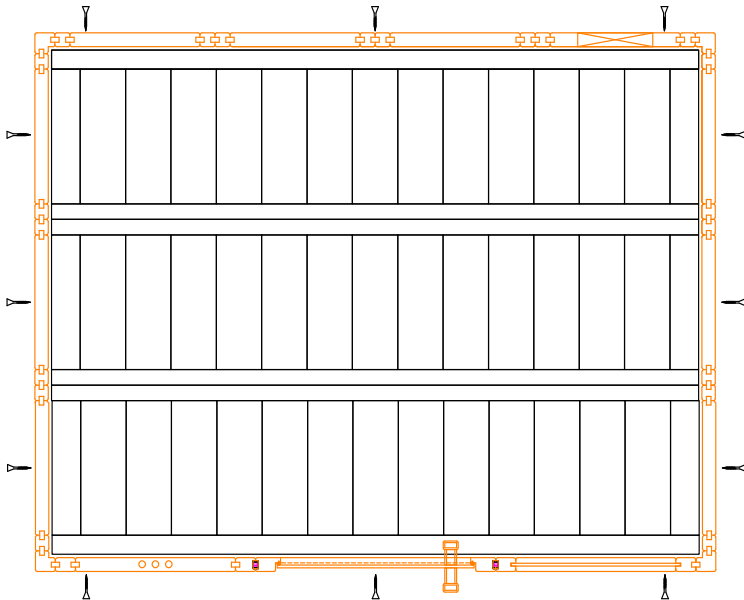

EN

3 mm drill bit, 12 screws 4 x 70 mm

2.4. Ventilation slit installation



3 mm drill bit, 4 screws 3.5 x 40 mm

2.5. Installing interior fittings

Bench support slats

3 mm drill bit, 3 screws 5 x 70 mm



2 screws 4 x 60 mm

3 mm drill bit, 3 screws 5 x 70 mm



EN

2 screws 4 x 60 mm

Bench screen



4 screws 4 x 60 mm

Backrests



3 mm drill bit, 3 screws 3.5 x 40 mm



2.6. Installing accessories

Sauna lamp



Insert lamp
(not included in the scope of delivery)



3 mm drill bit, 2 screws



4 screws 3.5 x 40 mm

Heater protection grille



Before installing the heater protection grille, drill the outlet for the heater cable in the electrical element.



2 screws 3.5 x 40 mm



4 screws 3.5 x 40 mm



2.7. Installing glass door

The glass door can be hinged to the left or right.



Silicone or paper insert for glass door fittings on both sides of the glass door

EN



screws 4 x 30 mm

Door handle

The door handles are screwed together from the inside.



Insert silicone ring in the drill holes



Symbolphoto

Door magnet and sleeve plate



2.8. Installing roof trim

 Install the roof trim only after you have inserted the cable to the sauna heater and to the sauna control unit. The slat on the electrical element may possibly have to be cropped.



3 mm drill bit, 10 screws 3.5 x 40 mm

2.9. Installing ceiling cover slat



Install the ceiling cover slat only after you have inserted the cable to the sauna heater and to the sauna control unit. The slat on the electrical element may possibly have to be cropped.



12 screws 3.5 x 40 mm

3. Floor plan

3.1. Left floor plan

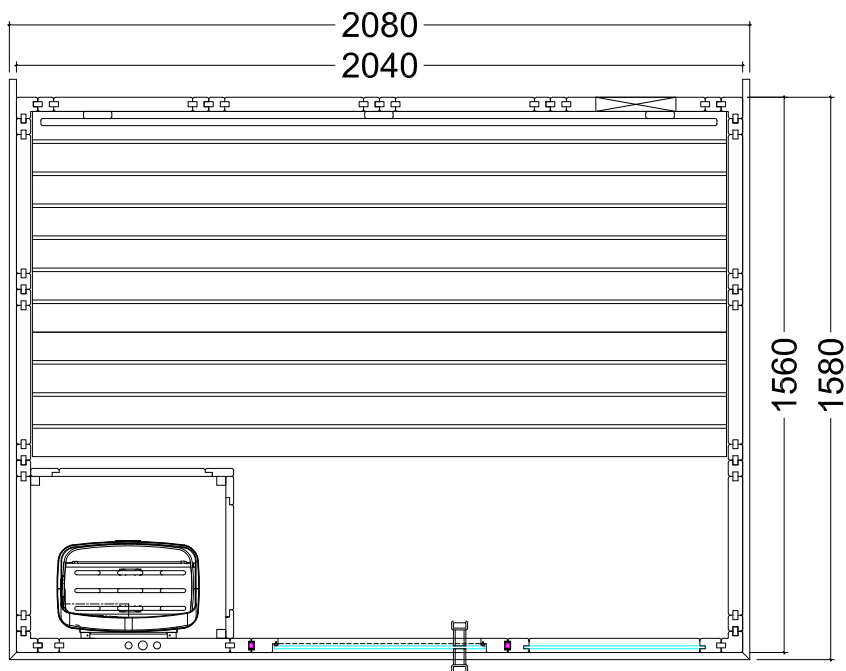

3.2. Right floor plan

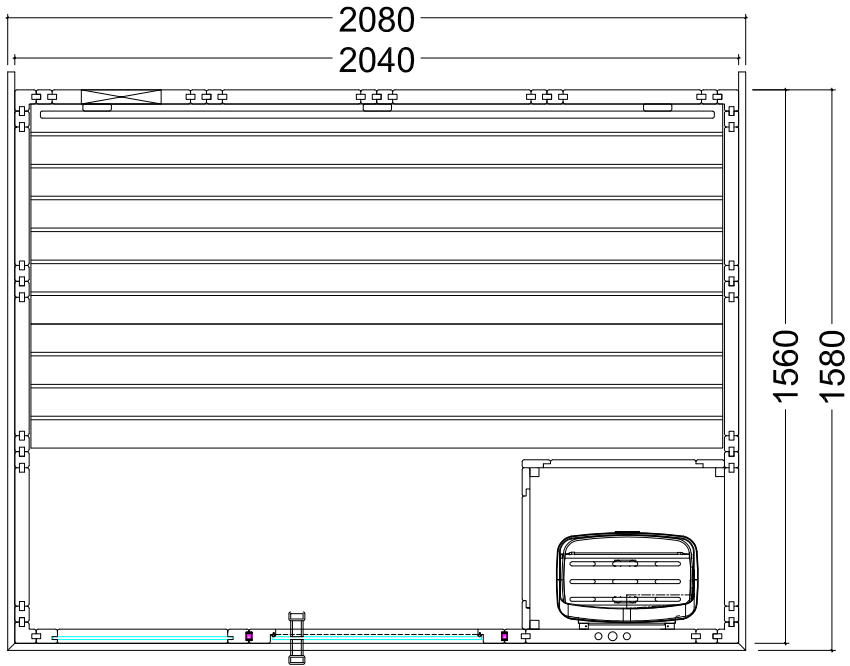



sentiotec GmbH | Division of Harvia Group | Wartenburger Straße 31, A-4840 Vöcklabruck
T +43 (0) 7672/22 900-50 | F -80 | info@sentiotec.com | www.sentiotec.com

Sauna en bois massif

Komfort

Small

208 x 158 x 204 cm

INSTRUCTIONS DE MONTAGE ET MODE D'EMPLOI
Français



FR

Table des matières

1. Préparation du montage	3
1.1. Outils requis	4
1.2. Entretien et nettoyage	5
1.3. Élimination	5
1.4. Nomenclature KOMFORT SMALL	6
2. Montage de la cabine	8
2.1. Montage du cadre de plancher	8
2.2. Montage des éléments muraux	9
2.3. Montage du toit	14
2.4. Montage du registre d'aération	16
2.5. Montage de l'équipement intérieur	16
2.6. Montage des accessoires	19
2.7. Montage de la porte en verre	21
2.8. Montage de la couronne	24
2.9. Montage de la baguette couvre-joint	25
3. Plan	26
3.1. Plan « à gauche »	26
3.2. Plan « à droite »	27

1. Préparation du montage

Lisez attentivement les présentes instructions de montage et gardez-les à proximité de l'appareil. Vous avez ainsi accès à tout moment aux informations sur le produit.



Vous trouverez également ces instructions de montage dans la rubrique de téléchargement de notre site Internet www.sentiotec.com/downloads.

Remarques importantes :

- Avant de commencer les travaux, vérifiez au moyen de la nomenclature si toutes les pièces ont bien été livrées. S'il devait s'avérer que des pièces manquent, informez votre revendeur dans les 14 jours suivant la réception de la cabine.
- La pièce dans laquelle la cabine de sauna va être montée doit être sèche et disposer d'une circulation suffisante de l'air.
- Le sol doit être horizontal et lisse, de préférence en pierre ou carrelage.
- Pour les travaux de montage de la cabine, la pièce doit faire au moins 230 cm de haut.
- Une distance d'au moins 5 cm avec le mur doit être respecté.
- Les pièces en bois prévues pour l'intérieur ne doivent pas être traitées avec un agent d'imprégnation.
- Une deuxième personne doit être disponible pour vous aider.
- Malgré un stockage correct, le bois est un produit naturel qui peut gonfler, se contracter ou se déformer. C'est pourquoi il peut arriver que vous ayez à appliquer de la force lors du montage.
- Tous les raccords vissés doivent être préalésés.

Attention !

Seul un électricien spécialisé ou une personne ayant une qualification similaire est habilité à procéder au raccordement électrique.

1.1. Outils requis

- Marteau et cales ou maillet en caoutchouc
- Visseuse électrique avec bits pour vis en croix et Torx
- Ruban de mesure
- Foret de 3 mm de diamètre, 10 mm, 20 - 30 mm (pour câble électrique poêle de sauna)
- Niveau à bulle
- Clé Allen 1,5 mm
- Couteau universel
- Échelle
- Scie fine



Ce symbole désigne les conseils et indications utiles.



Préalésage



Sciage à la bonne longueur avec une scie fine



Contrôle de l'angle droit :

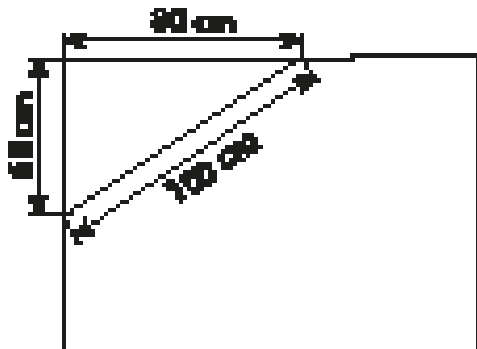

1.2. Entretien et nettoyage

- Le sauna doit être nettoyé au moyen d'un chiffon humide. N'utilisez que de l'eau chaude, pas de détergent.
- Si le sauna n'est pas utilisé pendant une période prolongée, nous recommandons de chauffer la cabine une fois par mois.



Les poches de résine ne constituent pas un motif de réclamation. en raison de leur présence régulière dans le bois d'épicéa et de l'impossibilité de déterminer leur profondeur lors de la sélection du bois.

Si elles se trouvent juste sous la surface, elles éclatent et s'écoulent quand elle sont exposées à la chaleur.

Retirez la résine écoulee à l'aide "un chiffon imbibé d'acétone. Si vous constatez uniquement des gouttes de résine, attendez qu'elles aient durci, puis grattez-les avec précaution à l'aide d'un couteau.

1.3. Élimination



- Éliminez les matériaux d'emballage conformément aux directives en vigueur relatives à l'élimination.
- Les appareils usagés contiennent des matériaux recyclables, mais aussi des substances toxiques. Par conséquent, ne jetez en aucun cas votre appareil usagé avec les déchets ménagers. Éliminez-le conformément aux directives locales en vigueur.

1.4. Nomenclature KOMFORT SMALL

Az	Désignation	Dimensions
Cadre de plancher		
2	Cadre de plancher	66 x 9 x 4 cm
1	Cadre de plancher	204 x 9 x 4 cm
2	Cadre de plancher	156 x 9 x 4 cm
Éléments muraux		
6	Éléments muraux A/A	193 x 48 x 4 cm
3	Éléments muraux A/B	193 x 48 x 4 cm
1	Élément de ventilation A/B	193 x 48 x 4 cm
1	Élément électrique A/A	193 x 60 x 4 cm
1	Élément mural avec verre	193 x 60 x 4 cm
1	Cadre de porte sans seuil avec multiclips	202 x 72 x 4 cm
Éléments du toit		
2	Éléments du toit	194 x 49 x 4 cm
1	Éléments du toit	194 x 48 x 4 cm
Montant d'angle		
4	Montant d'angle à 90°	193 x 6 x 6 cm
Baguettes d'appui		
2	Baguettes d'appui de toit	196 x 4 x 4 cm
2	Baguettes d'appui de toit	145 x 4 x 4 cm
2	Baguettes couvre-joints de toit	192 x 1,2 x 4 cm
2	Baguettes couvre-joints de toit	152 x 1,2 x 4 cm
2	Baguettes d'appui de banc	58 x 4 x 4 cm
2	Baguettes d'appui de banc	100 x 4 x 4 cm
2	Baguettes de montage pour écran de banc	26 x 4 x 4 cm

Az Désignation	Dimensions
Équipement intérieur	
1 Bancs	195 x 62 x 9 cm
1 Banc	195 x 53 x 9 cm
1 Dossiers	190 x 26 x 4 cm
1 Écran de banc	195 x 35 x 4 cm
1 Grille de protection du poêle - tilleul	57 x 75 x 2 cm
1 Grille de protection du poêle - tilleul	45,5 x 55 x 2 cm
1 Appuie-tête	43 x 25 x 7 cm
1 Grille de protection de lampe	38 x 32 x 4 cm
1 Registres d'aération	52 x 14 x 1,5 cm
1 Grille de plancher	70 x 53 x 4 cm
Éléments en verre	
1 Porte en verre	191,5 x 59 x 0,8 cm
Baguettes de la couronne	
1 Baguette de la couronne	208 x 6 x 4 cm
2 Baguettes de la couronne	163 x 6 x 4 cm
Accessoires	
1 Kit poignée bois/bois	
1 2 charnières 3308	
1 Aimant de porte, tôle extérieure	
1 Éclairage de sauna	
1 3 mètres linéaires Câble silicone 5 x 2,5 mm ²	
1 3 mètres linéaires Câble silicone 3 x 1,5 mm ²	
32 Capuchons de protection	
1 Kit de matériel de montage	
1 Instructions de montage	

2. Montage de la cabine

La cabine peut être montée « à droite » ou « à gauche ». Référez-vous aux plans Page 26 et Page 27.

2.1. Montage du cadre de plancher

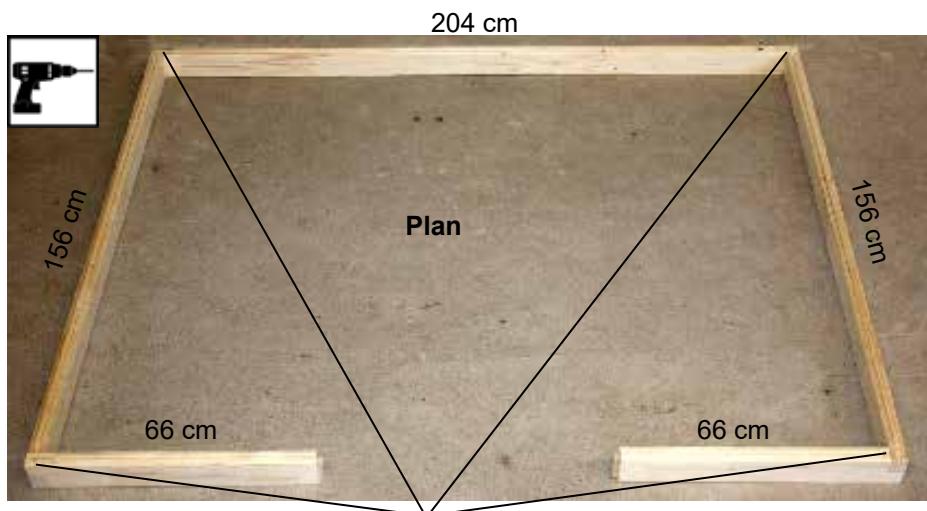

Foret de 3 mm, 4 vis 4 x 70 mm



2.2. Montage des éléments muraux

Les montants d'angle et éléments muraux sont reliés par des rainures et des languettes, et sont vissés les uns aux autres. Le cadre de porte est relié aux éléments muraux par des « multiclips ».



A désigne toujours le côté apparent qui est indiqué sur la face supérieure des éléments muraux.

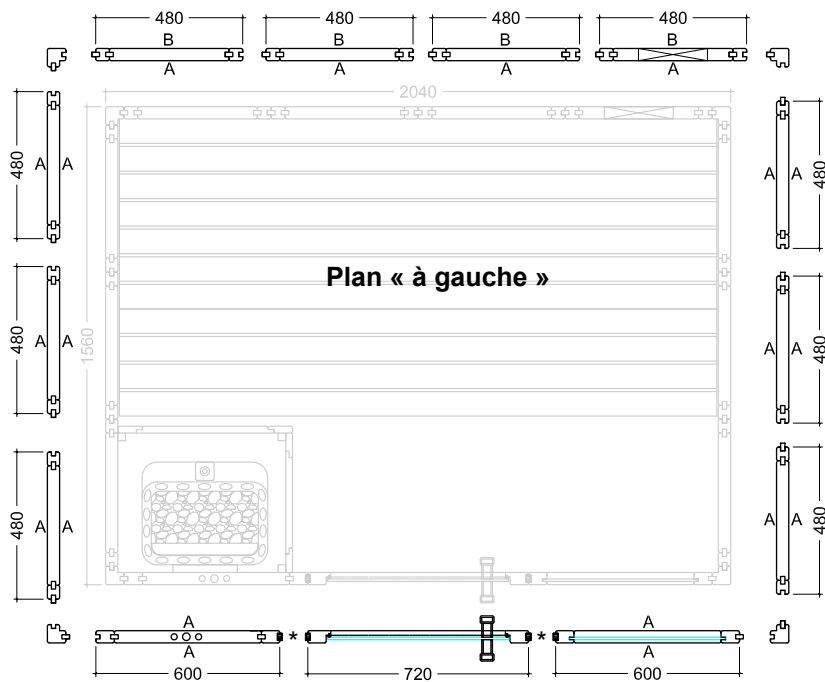

* Multiclips



8 vis 6 x 120 mm
par montant d'angle



photo non contractuelle



photo non contractuelle

Montage des éléments muraux



Des trous sont prévus sur l'élément électrique afin de poser le câble.
Pour la position, consultez Page 26 et Page 27.



Élément électrique à gauche
- sortie d'air derrière à droite.



photo non contractuelle

Élément électrique à droite
- sortie d'air derrière à gauche.



photo non contractuelle

FR



4 vis 6 x 100 mm

photo non contractuelle

Insérer le cadre de porte

Retirer la barre de transport du cadre de porte



Insérer le cadre de porte

Placez le cadre de porte du haut vers le bas sur les éléments muraux. Assurez-vous que l'orientation des « multiclips » est correcte (voir ci-dessous). Le cadre de porte doit être à fleur avec les éléments muraux.



Multiclip



Vissage des éléments muraux



Contrôlez les angles droits avant de visser les éléments muraux.
Consultez le conseil page 4.



Foret de 3 mm, 15 vis 4 x 70 mm

FR

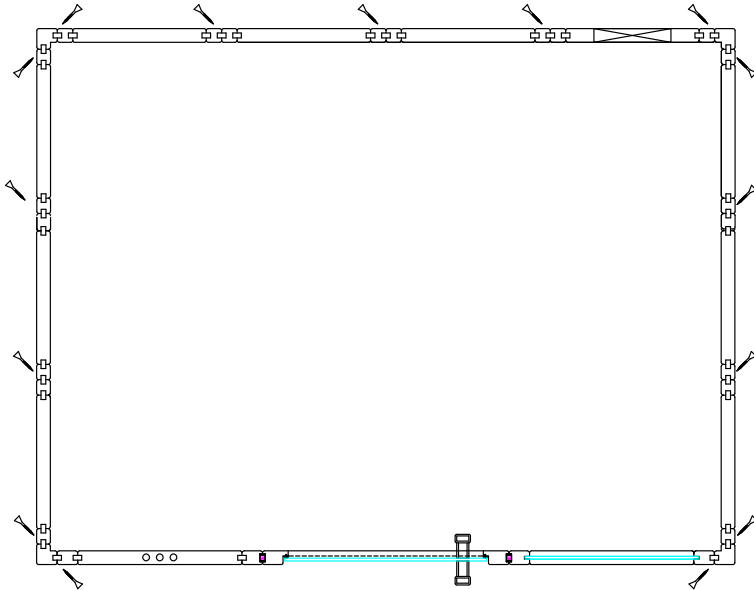

2.3. Montage du toit

Baguettes d'appui de toit



14 vis 4 x 70 mm

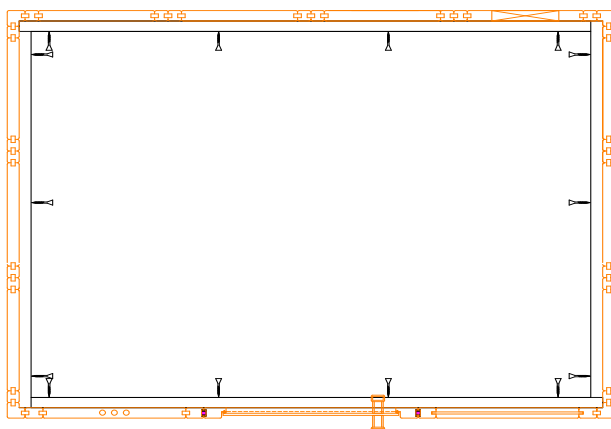

Éléments du toit



photo non contractuelle

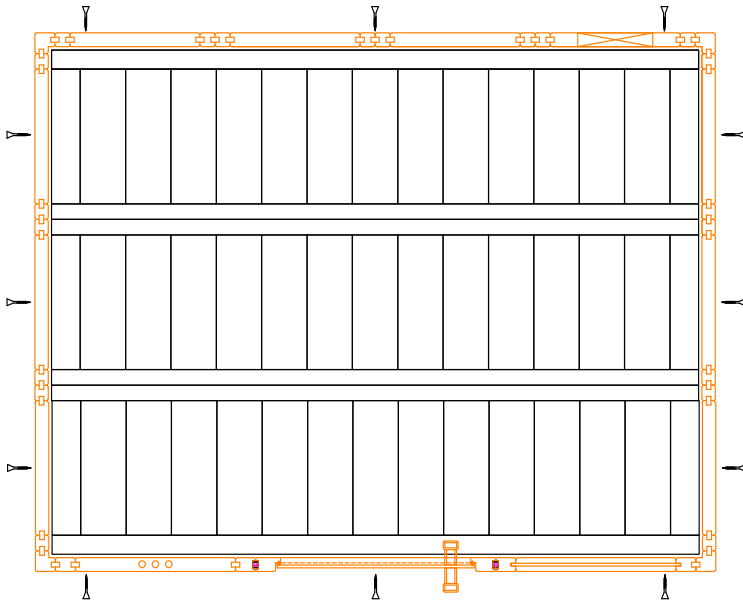

FR

Foret de 3 mm, 12 vis 4 x 70 mm

2.4. Montage du registre d'aération



Foret de 3 mm, 4 vis 3,5 x 40 mm

2.5. Montage de l'équipement intérieur

Baguettes d'appui de banc

Foret de 3 mm, 3 vis 5 x 70 mm

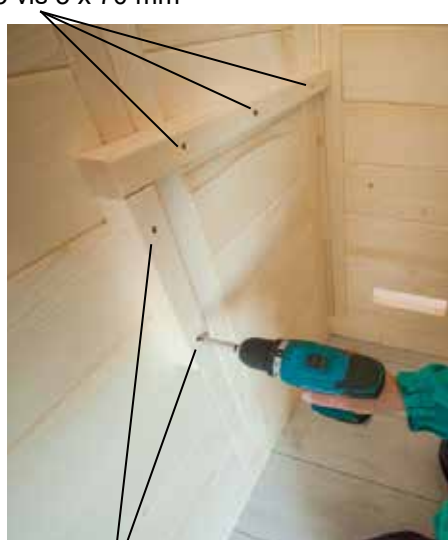

2 vis 4 x 60 mm

Foret de 3 mm, 3 vis 5 x 70 mm



2 vis 4 x 60 mm

FR

Écran de banc



4 vis 4 x 60 mm

Dossier



Foret de 3 mm, 4 vis 3,5 x 40 mm



2.6. Montage des accessoires

Éclairage de sauna



Mise en place des ampoules
(non compris dans la livraison)



Foret de 3 mm, 2 vis



4 vis 3,5 x 40 mm

Grilles de protection de poêle

 Avant le montage de la grille de protection du poêle, percez la sortie pour le câble du poêle dans l'élément électrique.



2 vis 3,5 x 40 mm



4 vis 3,5 x 40 mm



2.7. Montage de la porte en verre

La porte en verre peut être ouverte à gauche ou à droite.



Insert en silicone ou en papier pour ferrures de porte en verre des deux côtés de la porte en verre

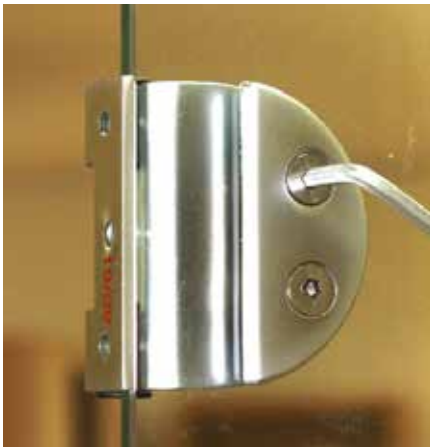

Vis 4 x 30 mm

Poignée de porte

Les poignées sont vissées ensemble depuis l'intérieur.

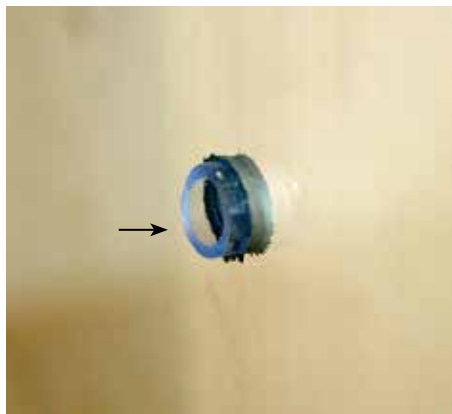

Introduction de la bague en silicone dans les alésages



photo non contractuelle

Aimant de porte et tôle extérieure



2.8. Montage de la couronne



Ne montez la couronne qu'après avoir inséré les câbles vers le poêle de sauna et la commande de sauna. La baguette au niveau de l'élément électrique doit éventuellement être coupée.



Foret de 3 mm, 10 vis 3,5 x 40 mm

2.9. Montage de la baguette couvre-joint

 Ne montez la baguette couvre-joint qu'après avoir inséré les câbles menant au poêle de sauna et à la commande de sauna. La baguette au niveau de l'élément électrique doit éventuellement être coupée.



12 vis 3,5 x 40 mm

3. Plan

3.1. Plan « à gauche »

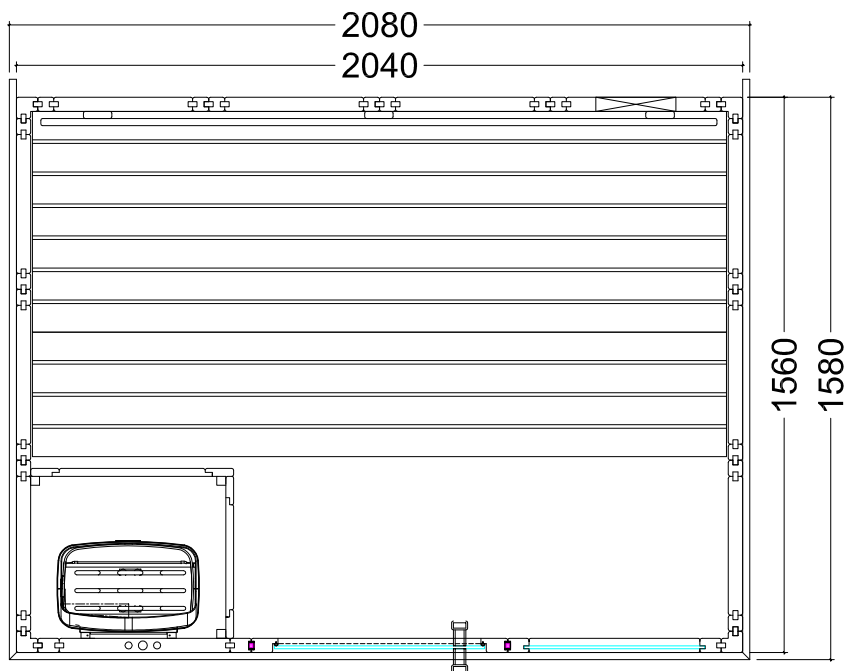

3.2. Plan « à droite »

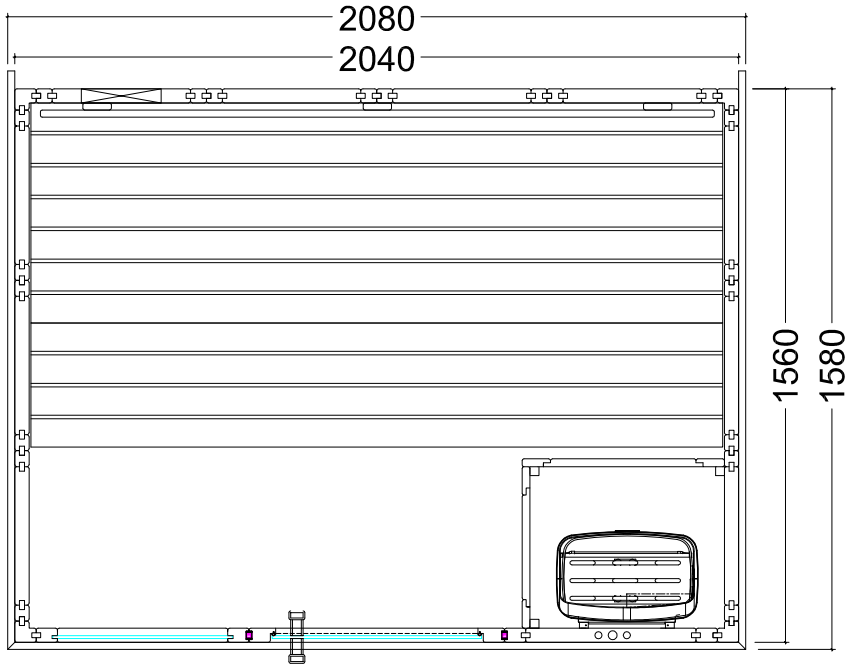



sentiotec GmbH | Division of Harvia Group | Wartenburger Straße 31, A-4840 Vöcklabruck
T +43 (0) 7672/22 900-50 | F -80 | info@sentiotec.com | www.sentiotec.com